

Mehr Produkte finden Sie
in unserem Katalog!





Art. 779 160

Grillkota 9 de luxe



mit Saunaanbau Dachschindeln schwarz

45 mm / 376x576 cm / 14,2 m²

DIMENSIONEN

	Bohlenstärke	45 mm
	Innenmaß Saunaanbau	367x317 cm 191x245 cm
	Sockelmaß	376x576 cm
	Gesamtmaß	426x630 cm
	Grundfläche	14,2 m ²
	Rauminhalt	33,2 m ³
	Firsthöhe	364 cm
	Seitenwandhöhe	154 cm
	Dachüberstand vorne/seitlich/hinten	29/29/25 cm

DACH

	Dachneigung	45°
	Dachfläche	20,0 m ²
	Dachbretter	18 mm

TÜR/ FENSTER

	Einzeltür (Isoglas)	71x165 cm
	Sauna-Glastür (Sicherheitsglas)	69x189 cm
	Einzelfenster (2 Stück, isolierverglast, Schwing)	82x44 cm
	Dreieckfenster (1 Stück, isolierverglast, feststehend)	97x48 cm

VERPACKUNG

	Paketabmessung Paket 1/ Paket 2	220/240x120x250 cm
	Paketgewicht	2.000 kg

ZUBEHÖR (zzgl.)

	Farbige Dachschindeln in rot oder grün Dachrinne Kunststoff 482KA braun Elektroofen 9 KW mit integr. Steuerung Elektroofen 9 KW mit externer Steuerung Bioofen 9 KW mit externer Steuerung Weiteres Zubehör finden Sie im Katalog
--	---

**5 JAHRE
GARANTIE**

**INKLUSIVE HOCHWERTIGE
GRILLANLAGE**



Grundriss

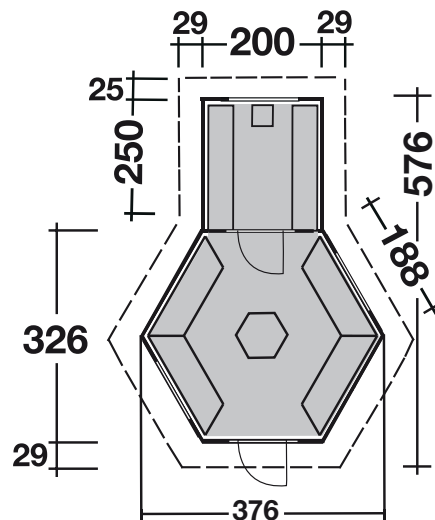

Weitere Informationen finden Sie unter: www.finnhaus.de oder im aktuellen Katalog.
Technische Änderungen, Druckfehler und Irrtümer vorbehalten.